

DATA SHEET

SKY13314-374LF: 0.1-6.0 GHz GaAs SPDT Switch

Applications

- Dual-band WLAN systems

Features

- Positive low voltage control: 0 and 3.3 V
- Low insertion loss: 0.45 dB @ 2.5 GHz and 0.60 dB @ 6.0 GHz
- Excellent linearity performance: P1dB = +31 dBm
- Advanced pHEMT process
- Ultra-thin, miniature MLPD (6-pin, 1.5 x 1.5 x 0.45 mm) package (MSL1, 260 °C per JEDEC J-STD-020)

NEW



Skyworks Green™ products are RoHS (Restriction of Hazardous Substances)-compliant, conform to the EIA/EICTA/JEITA Joint Industry Guide (JIG) Level A guidelines, are halogen free according to IEC-61249-2-21, and contain <1,000 ppm antimony trioxide in polymeric materials.

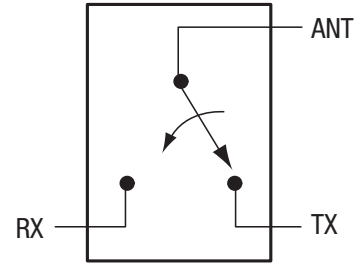

Figure 1. SKY13314-374LF Block Diagram

Description

The SKY13314-374LF is a pHEMT GaAs I/C antenna switch. Switching between the antenna and TX or RX ports is accomplished with two control voltages. The low-loss, high isolation, high linearity, small size and low cost make this switch ideal for all dual-band WLAN systems that operate at 2.4 to 2.5 GHz and 4.9 to 5.9 GHz.

The switch is manufactured in a compact, 1.5 x 1.5 mm, 6-pin exposed pad plastic Micro Leadframe Package Dual (MLPD) package.

A functional block diagram is shown in Figure 1. The pin configuration and package are shown in Figure 2. Signal pin assignments and functional pin descriptions are provided in Table 1.

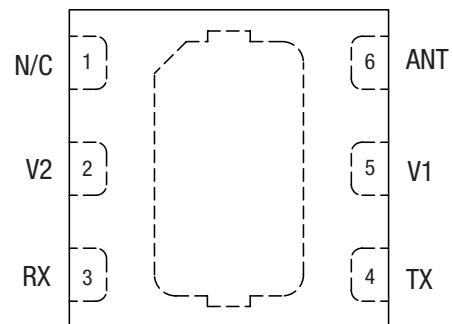

Figure 2. SKY13314-374LF Pinout – 6-Pin MLPD (Top View)

Table 1. SKY13314-374LF Signal Descriptions

Pin #	Name	Description	Pin #	Name	Description
1	N/C	No connection	4	ANT	RF common port (must be DC blocked)
2	V2	DC control voltage	5	V1	DC control voltage
3	RX	RF port (must be DC blocked)	6	TX	RF port (must be DC blocked)

Table 2. SKY13314-374LF Absolute Maximum Ratings

Parameter	Symbol	Minimum	Typical	Maximum	Units
Input power @ 0 and 3 V	P _{IN}			+33	dBm
Input power @ 0 and 5 V	P _{IN}			+35	dBm
Operating voltage	V _{CTL}			6.0	V
Storage temperature	T _{STG}	-65		+150	°C
Operating temperature	T _{OP}	-40		+85	°C

Note: Exposure to maximum rating conditions for extended periods may reduce device reliability. There is no damage to device with only one parameter set at the limit and all other parameters set at or below their nominal value. Exceeding any of the limits listed here may result in permanent damage to the device.

CAUTION: Although this device is designed to be as robust as possible, Electrostatic Discharge (ESD) can damage this device. This device must be protected at all times from ESD. Static charges may easily produce potentials of several kilovolts on the human body or equipment, which can discharge without detection. Industry-standard ESD precautions should be used at all times.

Electrical and Mechanical Specifications

The absolute maximum ratings of the SKY13314-374LF are provided in Table 2. Electrical specifications are provided in Table 3.

Typical performance characteristics of the SKY13314-374LF are illustrated in Figures 3 through 9.

The state of the SKY13314-374LF is determined by the logic provided in Table 4.

Table 3. SKY13314-374LF Electrical Specifications (Note 1)**($V_{CTL} = 0\text{ V}$ and $+3.3\text{ V}$, $T_{OP} = +25\text{ }^{\circ}\text{C}$, $P_{IN} = 0\text{ dBm}$, Characteristic Impedance [Z_0] = $50\text{ }\Omega$, Unless Otherwise Noted)**

Parameter	Symbol	Test Condition	Min	Typical	Max	Units
Insertion loss, ANT to TX and RX ports		2.4-2.5 GHz		0.45	0.65	dB
		0.1-3.0 GHz		0.50	0.70	dB
		3.0-6.0 GHz		0.60	0.85	dB
Isolation, ANT to TX and RX ports		2.4-2.5 GHz	19	22		dB
		0.1-3.0 GHz	18	21		dB
		3.0-6.0 GHz	18	21		dB
Return loss (Note 2), ANT to TX and RX ports (insertion loss state)		2.4-2.5 GHz	14	21		dB
		0.1-3.0 GHz	12	18		dB
		3.0-6.0 GHz	12	15		dB
Switching characteristics: Rise/fall time On/off time		10/90% or 90/10% RF		15		ns
		50% V_{CTL} to 90/10% RF		30		ns
Video feedthrough		$T_{RISE} = 1\text{ ns @ }500\text{ MHz}$		50		mV
Input power for 1 dB compression	P1dB	$V_{CTL} = 0$ and 3.3 V , 2.4-2.5 GHz 4.9-5.9 GHz		+31 +31		dBm dBm
		$V_{CTL} = 0$ and 1.8 V , 2.4-2.5 GHz 4.9-5.9 GHz		+27.5 +21.5		dBm dBm
Input IP3	IIP3	For two-tone input power = $+17\text{ dBm/ tone}$, 1 MHz spacing, $V_{CTL} = 0$ and 3.3 V , 2.4-2.5 GHz		+47		dBm
Error Vector Magnitude	EVM	802.11a, 54 Mbps, $P_{IN} = <+20.5\text{ dBm}$, $V_{CTL} = 3\text{ V}$		2.5		%
		802.11g, 54 Mbps, $P_{IN} = <+24.5\text{ dBm}$, $V_{CTL} = 3\text{ V}$		2.5		%
Control voltage: High Low	V_{CTL_H}		1.80	3.30	5.00	V
	V_{CTL_L}			0	0.25	V
Leakage current		V_{CTL_H} and V_{CTL_L}		5	50	μA

Note 1: Performance is guaranteed only under the conditions listed in this Table.**Note 2:** Low frequency return loss is limited by the value of DC blocking capacitors (15 pF).

Typical Performance Characteristics

($V_{CTL} = 0\text{ V}$ and $+3.3\text{ V}$, $T_{OP} = +25\text{ }^{\circ}\text{C}$, $P_{IN} = 0\text{ dBm}$, Characteristic Impedance [Z_0] = $50\text{ }\Omega$, Blocking Capacitors = 15 pF , Unless Otherwise Noted)

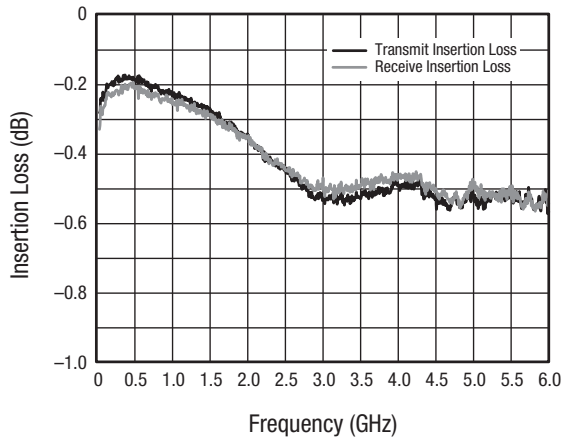

Figure 3. Typical Insertion Loss

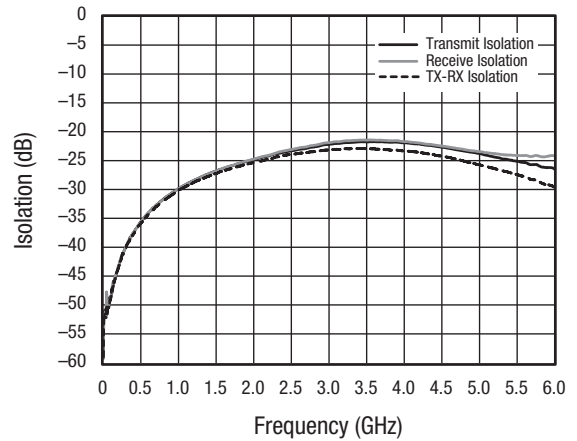

Figure 4. Typical Isolation

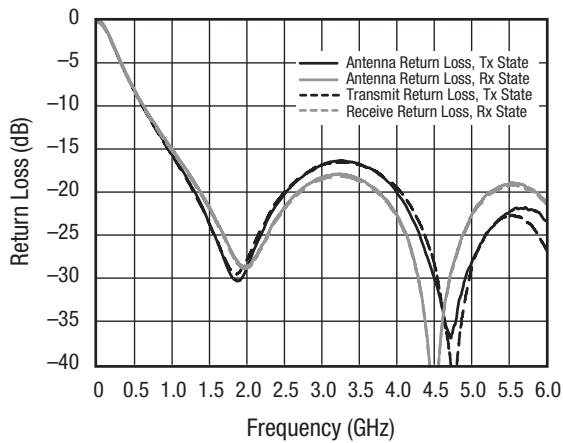

Figure 5. Typical Return Loss

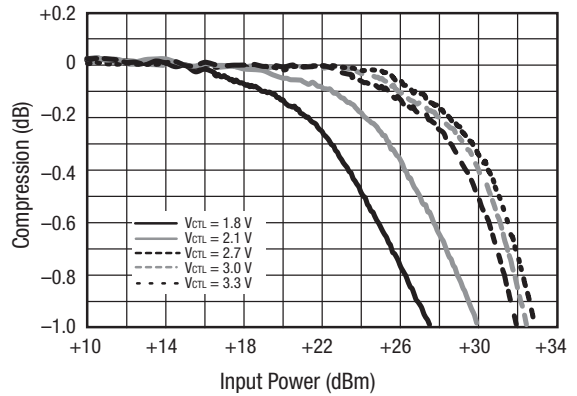

Figure 6. Typical Compression, 2.4-2.5 GHz

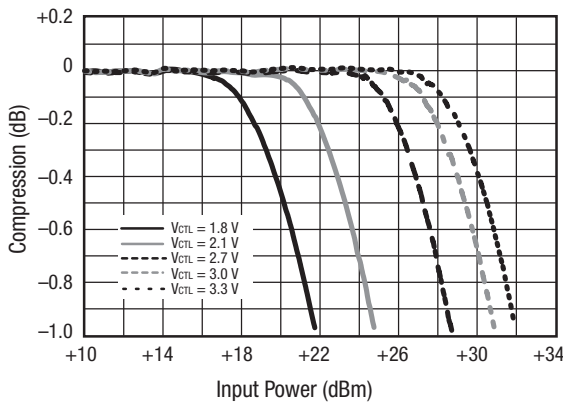

Figure 7. Typical Compression, 4.9-5.9 GHz

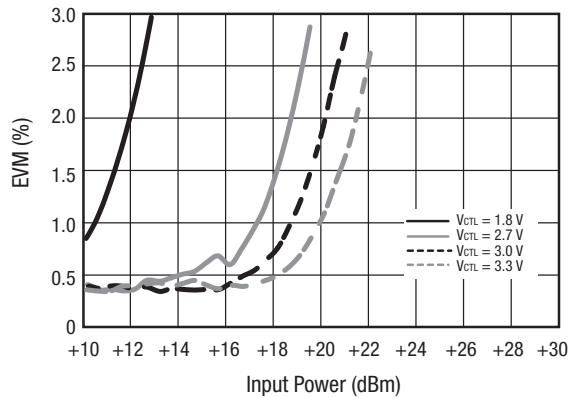

Figure 8. Typical 802.11a EVM, 4.9-5.9 GHz

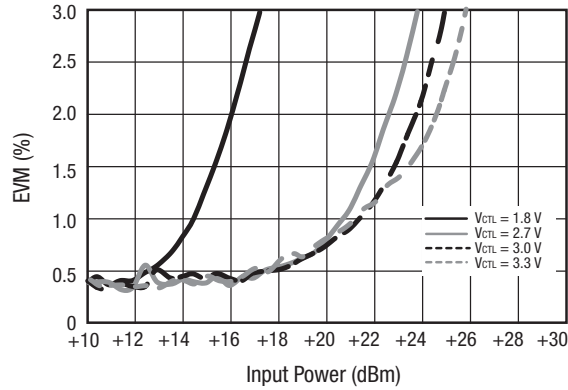

Figure 9. Typical 802.11g EVM, 2.4-2.5 GHz

Table 5. SKY13314-374LF Truth Table

V1 (Pin 5)	V2 (Pin 2)	ANT to RX Path	ANT to TX Path
1	0	Insertion loss	Isolation
0	1	Isolation	Insertion loss

Note: "1" = +1.8 V to +5.0 V. "0" = 0 V to +0.25 V. Any state other than described in this Table places the switch into an undefined state. An undefined state will not damage the device.

Evaluation Board Description

The SKY13314-374LF Evaluation Board is used to test the performance of the SKY13314-374LF SPDT Switch. An Evaluation Board schematic diagram is provided in Figure 10. An assembly drawing for the Evaluation Board is shown in Figure 11.

Package Dimensions

The PCB layout footprint for the SKY13314-374LF is provided in Figure 12. Typical case markings are shown in Figure 13. Package dimensions for the 6-pin MLPD are shown in Figure 14, and tape and reel dimensions are provided in Figure 15.

Package and Handling Information

Instructions on the shipping container label regarding exposure to moisture after the container seal is broken must be followed. Otherwise, problems related to moisture absorption may occur when the part is subjected to high temperature during solder assembly.

The SKY13314-374LF is rated to Moisture Sensitivity Level 1 (MSL1) at 260 °C. It can be used for lead or lead-free soldering.

Care must be taken when attaching this product, whether it is done manually or in a production solder reflow environment. Production quantities of this product are shipped in a standard tape and reel format. For packaging details, refer to the Skyworks Application Note, *Discrete Devices and IC Switch/Attenuators Tape and Reel Package Orientation*, document number 200083.

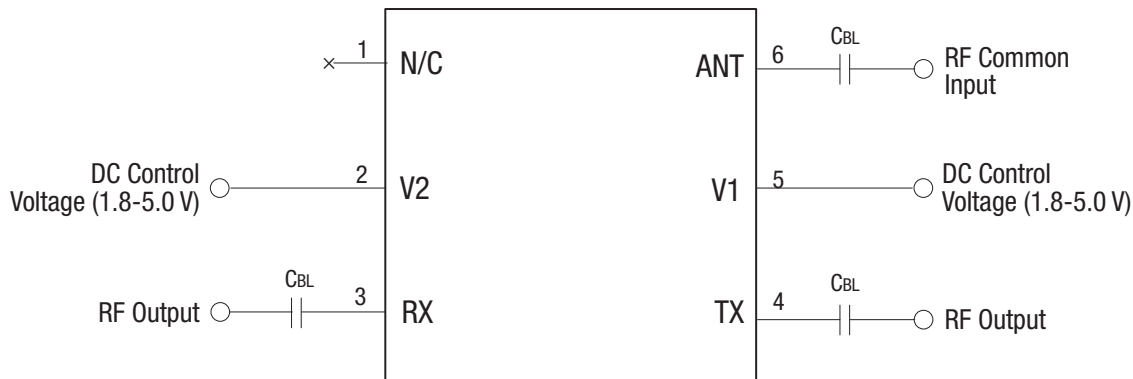

$C_{BL} = 15 \text{ pF}$ for 2.4-6.0 GHz operation.
Exposed ground paddle should be grounded for best performance.

S1639

Figure 10. SKY13314-374LF Evaluation Board Schematic

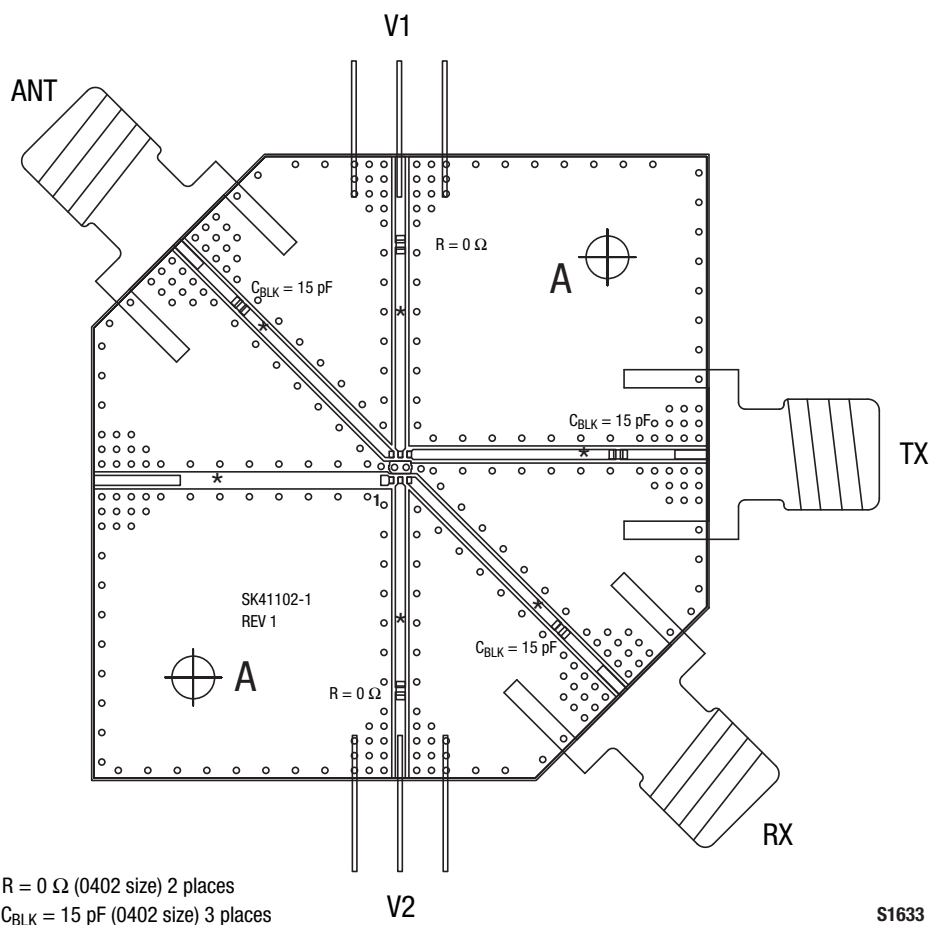

R = 0 Ω (0402 size) 2 places
 $C_{BLK} = 15 \text{ pF}$ (0402 size) 3 places

S1633

Figure 11. SKY13314-374LF Evaluation Board Assembly Diagram

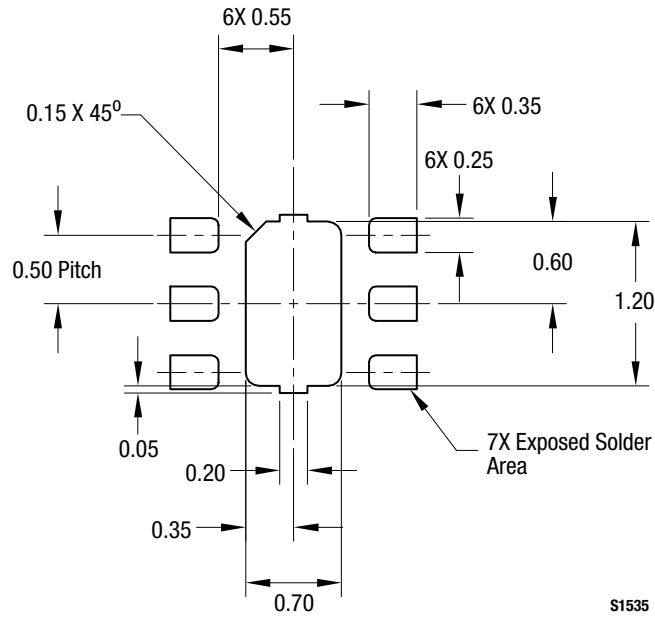

Figure 12. SKY13314-374LF PCB Layout Footprint (Top View)

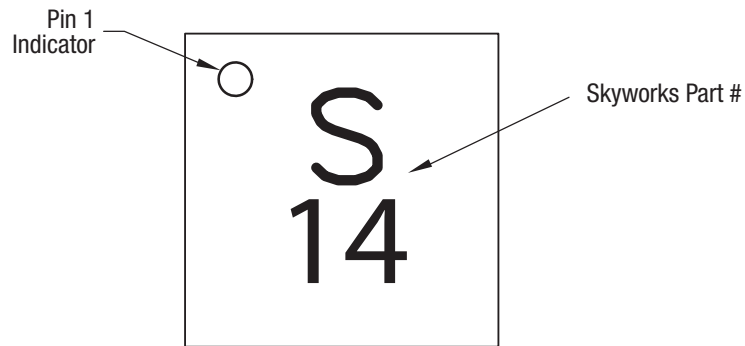
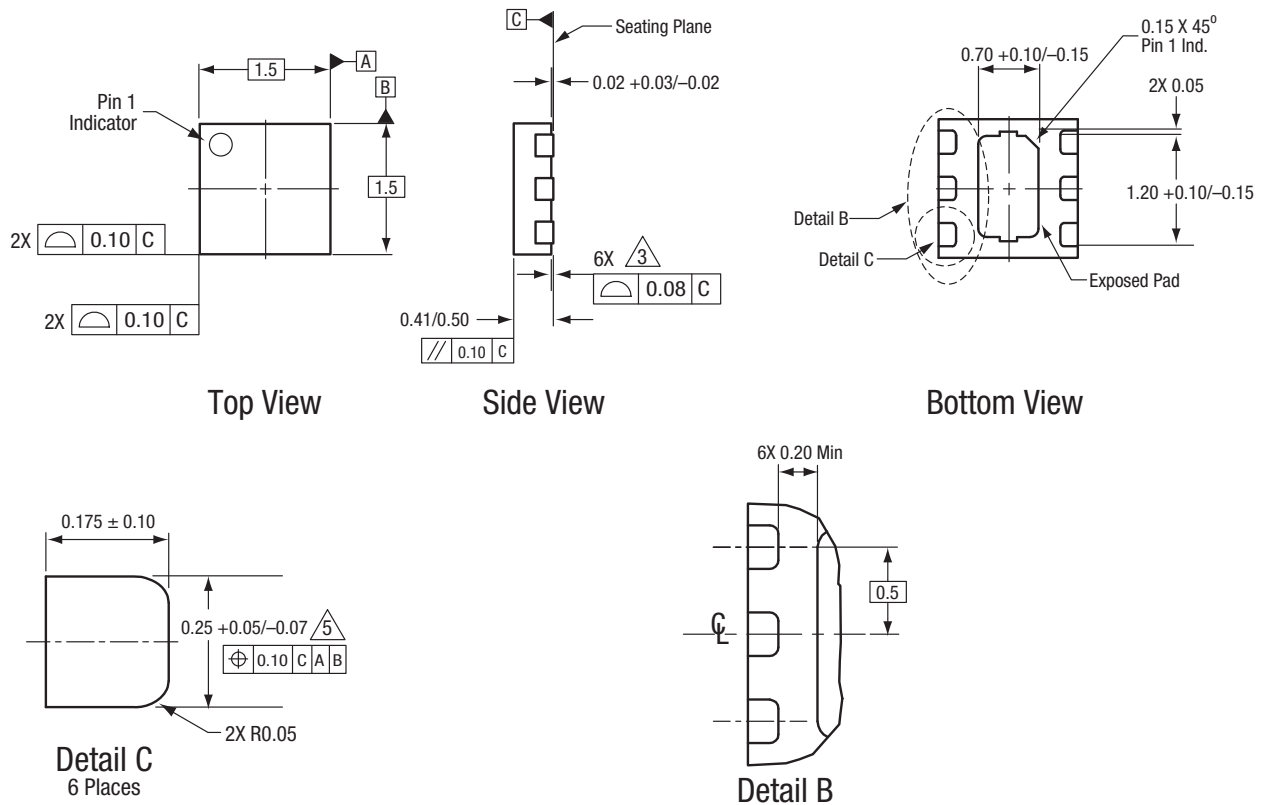

Figure 13. Typical Part Markings (Top View)



All measurements are in millimeters.
 Dimensioning and tolerancing according to ASME Y14.5M-1994.
 Coplanarity applies to the exposed heat sink slug as well as the terminals..
 Plating requirement per source control drawing (SCD) 2504.
 Dimension applies to metalized terminal and is measured between 0.15 mm and 0.30 mm from terminal tip.

S1536

Figure 14. SKY13314-374LF 6-Pin MLPD Package Dimensions

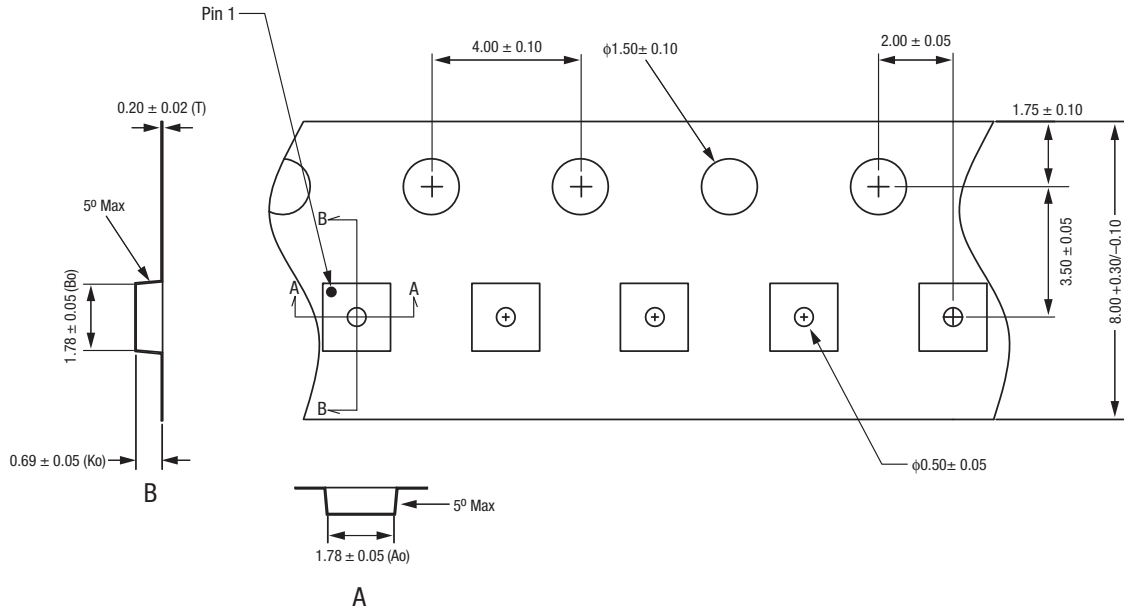

- Notes:
1. Carrier tape: black conductive polycarbonate or polystyrene.
 2. Cover tape material: transparent conductive PSA.
 3. Cover tape size: 5.4 mm width.
 4. All measurements are in millimeters.

S1382a

Figure 15. SKY13314-374LF Tape and Reel Dimensions

Ordering Information

Model Name	Manufacturing Part Number	Evaluation Board Part Number
SKY13314-374LF SPDT Switch	SKY13314-374LF	SK41102-1, Rev. 1

Copyright © 2008, 2009, 2010 Skyworks Solutions, Inc. All Rights Reserved.

Information in this document is provided in connection with Skyworks Solutions, Inc. (“Skyworks”) products or services. These materials, including the information contained herein, are provided by Skyworks as a service to its customers and may be used for informational purposes only by the customer. Skyworks assumes no responsibility for errors or omissions in these materials or the information contained herein. Skyworks may change its documentation, products, services, specifications or product descriptions at any time, without notice. Skyworks makes no commitment to update the materials or information and shall have no responsibility whatsoever for conflicts, incompatibilities, or other difficulties arising from any future changes.

No license, whether express, implied, by estoppel or otherwise, is granted to any intellectual property rights by this document. Skyworks assumes no liability for any materials, products or information provided hereunder, including the sale, distribution, reproduction or use of Skyworks products, information or materials, except as may be provided in Skyworks Terms and Conditions of Sale.

THE MATERIALS, PRODUCTS AND INFORMATION ARE PROVIDED “AS IS” WITHOUT WARRANTY OF ANY KIND, WHETHER EXPRESS, IMPLIED, STATUTORY, OR OTHERWISE, INCLUDING FITNESS FOR A PARTICULAR PURPOSE OR USE, MERCHANTABILITY, PERFORMANCE, QUALITY OR NON-INFRINGEMENT OF ANY INTELLECTUAL PROPERTY RIGHT; ALL SUCH WARRANTIES ARE HEREBY EXPRESSLY DISCLAIMED. SKYWORKS DOES NOT WARRANT THE ACCURACY OR COMPLETENESS OF THE INFORMATION, TEXT, GRAPHICS OR OTHER ITEMS CONTAINED WITHIN THESE MATERIALS. SKYWORKS SHALL NOT BE LIABLE FOR ANY DAMAGES, INCLUDING BUT NOT LIMITED TO ANY SPECIAL, INDIRECT, INCIDENTAL, STATUTORY, OR CONSEQUENTIAL DAMAGES, INCLUDING WITHOUT LIMITATION, LOST REVENUES OR LOST PROFITS THAT MAY RESULT FROM THE USE OF THE MATERIALS OR INFORMATION, WHETHER OR NOT THE RECIPIENT OF MATERIALS HAS BEEN ADVISED OF THE POSSIBILITY OF SUCH DAMAGE.

Skyworks products are not intended for use in medical, lifesaving or life-sustaining applications, or other equipment in which the failure of the Skyworks products could lead to personal injury, death, physical or environmental damage. Skyworks customers using or selling Skyworks products for use in such applications do so at their own risk and agree to fully indemnify Skyworks for any damages resulting from such improper use or sale.

Customers are responsible for their products and applications using Skyworks products, which may deviate from published specifications as a result of design defects, errors, or operation of products outside of published parameters or design specifications. Customers should include design and operating safeguards to minimize these and other risks. Skyworks assumes no liability for applications assistance, customer product design, or damage to any equipment resulting from the use of Skyworks products outside of stated published specifications or parameters.

Skyworks, the Skyworks symbol, and “Breakthrough Simplicity” are trademarks or registered trademarks of Skyworks Solutions, Inc., in the United States and other countries. Third-party brands and names are for identification purposes only, and are the property of their respective owners. Additional information, including relevant terms and conditions, posted at www.skyworksinc.com, are incorporated by reference.